

MLIT New Technology Information
System (NETIS) Registered Product
(Registration No. TH-120012-A)

Waterproofing that breathes

Rooftop Waterproofing Air Control

New waterproofing method helps extend the life of buildings and promotes conservation
by removing moisture and heat from inside a roof's waterproofing layer

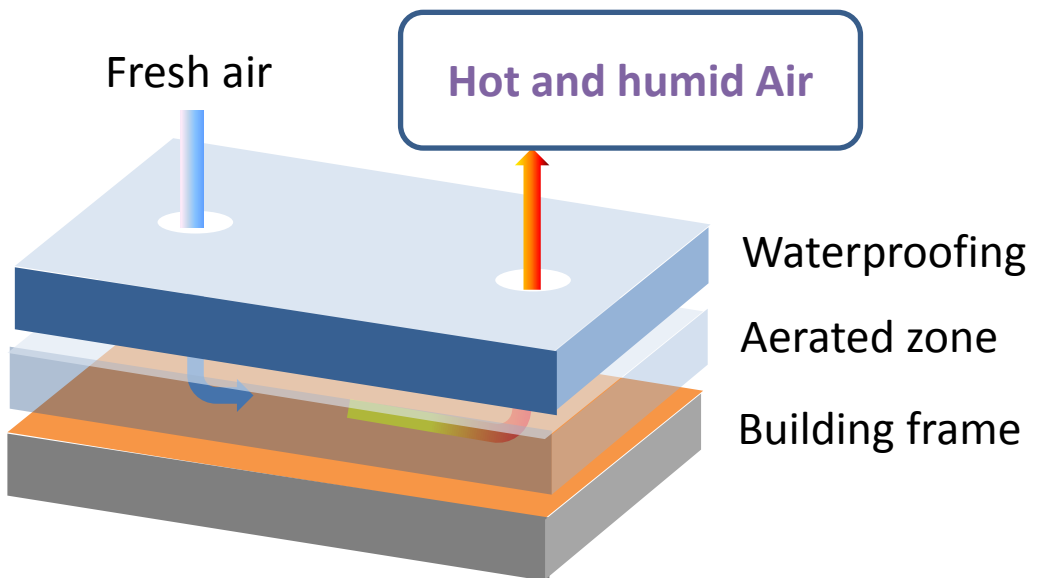

Fundamental Air Control (AC) Method

An Utsunomiya University/Oyama College/AIREC jointly developed product

To overcome the drawbacks of conventional methods focused on waterproofing properties, this collaborative project produced waterproofing that breathes, effectively discharging water accumulating inside the waterproofing layer by including a ventilation mechanism within the waterproofing layer. We have successfully created Air Control roof waterproofing that achieves excellent ventilation combinable with existing waterproofing methods.

■ Mechanism/Installation Standard

Deaeration cylinder ventilation capacity: Max 300 m²/1 unit

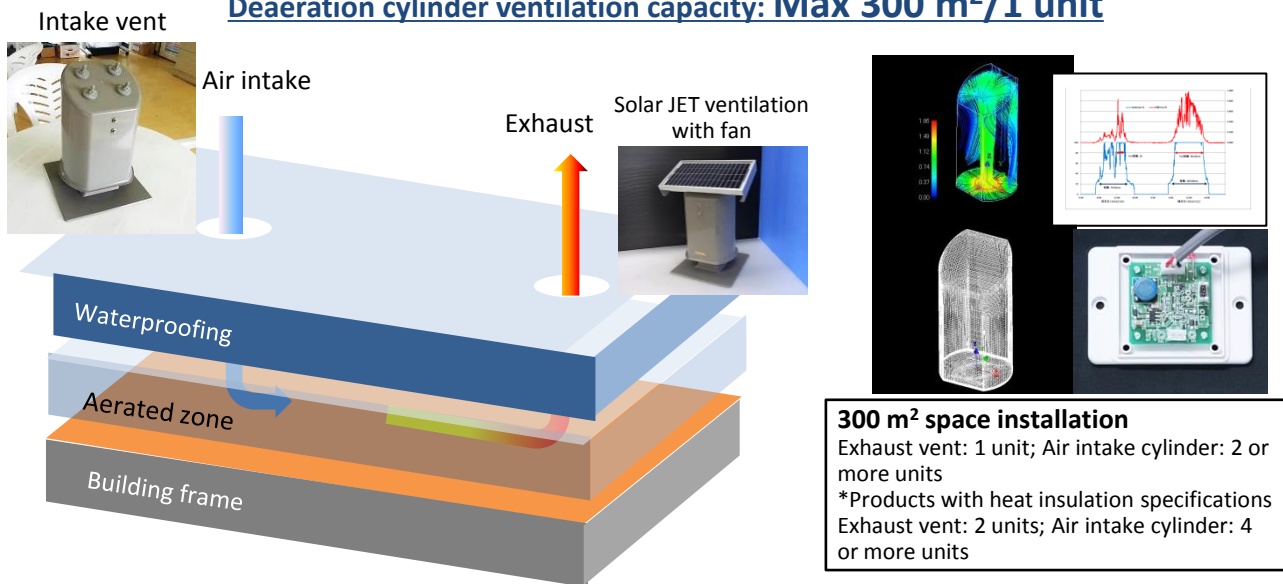

*When waterproofing layer is installed over insulation material, waterproofing layer may become hotter in summer compared to conventional methods, reaching around 80°C (Architectural Institute of Japan; Membrane Waterproofing Work, p. 125).

■ Benefits and Characteristics of the AC Method

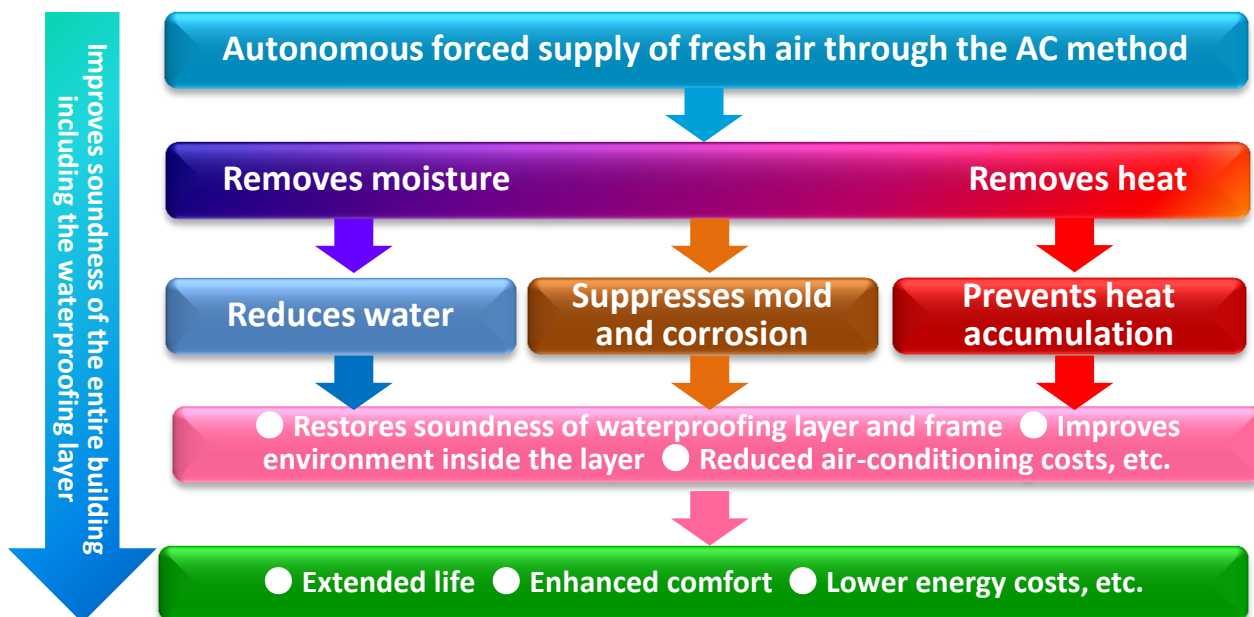

■ Data

(*Measured in Utsunomiya, Tochigi)

■ Conventional exhaust method

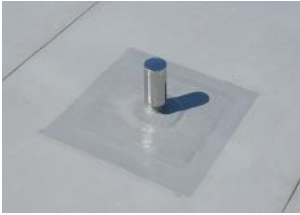

Natural ventilation exhaust vent (stainless steel)

Conventional deaeration method	Max summer temperature	Humidity	Lowest winter temperature	Humidity
Waterproofing layer surface	60 to 70°C		-10 to -15°C	
Inside waterproofing layer	59 to 68°C		-10 to -15°C	
Difference between layer surface and inside	1 to 2°C		0°C	
Skeleton surface	58°C		-10 to -15°C	
Exhaust from exhaust vent	Unmeasurable	Unmeasurable	Unmeasurable	Unmeasurable

■ Air Control (AC) method



Solar JET ventilation with fan

AC method	Max summer temperature	Humidity	Lowest winter temperature	Humidity
Waterproofing layer surface	65°C		-8 to -13°C	
Inside waterproofing layer	40°C or lower		-2 to -7°C	
Difference between layer surface and inside	20°C or higher		6°C or higher	
Skeleton surface	40°C or lower		-2°C	
Exhaust from exhaust vent	40°C or lower	300 g to 800 g/day	-2°C	100 g to 300 g/day

*For humidity, exhaust changes by site.

■ Construction

Urethane coating method

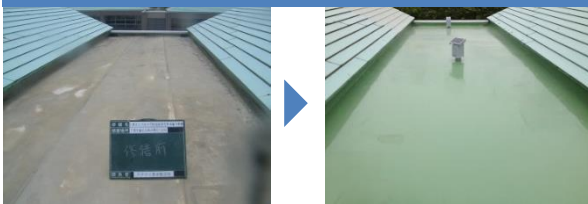

Aqueous acrylic coating method



Vinyl chloride sheet method



Modified asphalt method

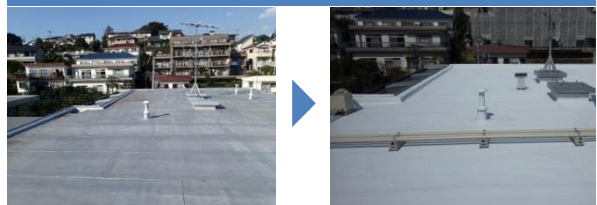

FRP sheet method



■ AC Method Equipment/Material Dimensions/Specifications

■ Solar JET ventilation



Name	Specifications	Size
Solar panel	Max. 17 V 6 W 0.35 A Newly designed electronic control circuit	335 mm × 188 × 16
Waterproof DC fan	12 V 1.2 W 0.1 A Max. air volume 0.65 m ³ /min Expected life 40,000 h	80 mm × 80 × 25
Exhaust vent Intake vent	Made with AES (t = 2.0 to 4.0 mm)	See product drawing

*AES plastic: Acrylonitrile Ethylene-propylene-diene Styrene

■ Intake vent



[Product Drawing]

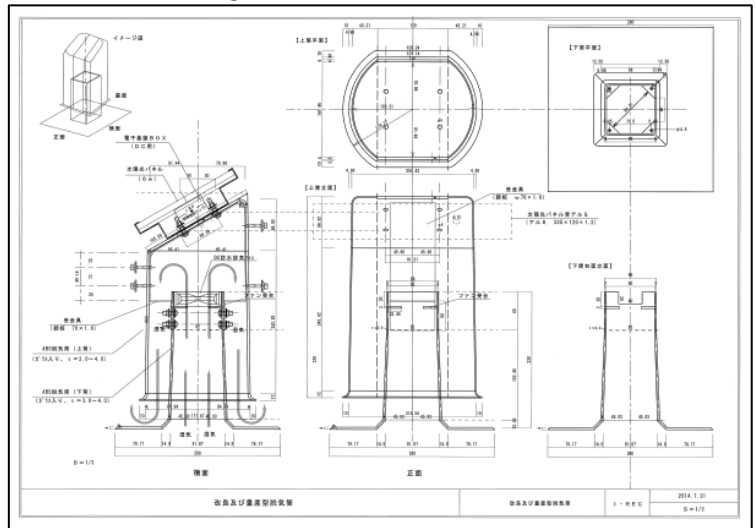

■ CORE CONE air-permeable material

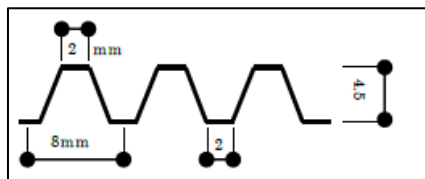
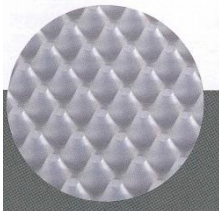

Name	Specifications	Size
CORE CONE air-permeable material	Polypropylene	H 4.5 mm × W 1,250 × 30 m
Surface pressure resistance	100 kg/10 cm ²	

Distributor